

Instruction Manual and Installation Instructions

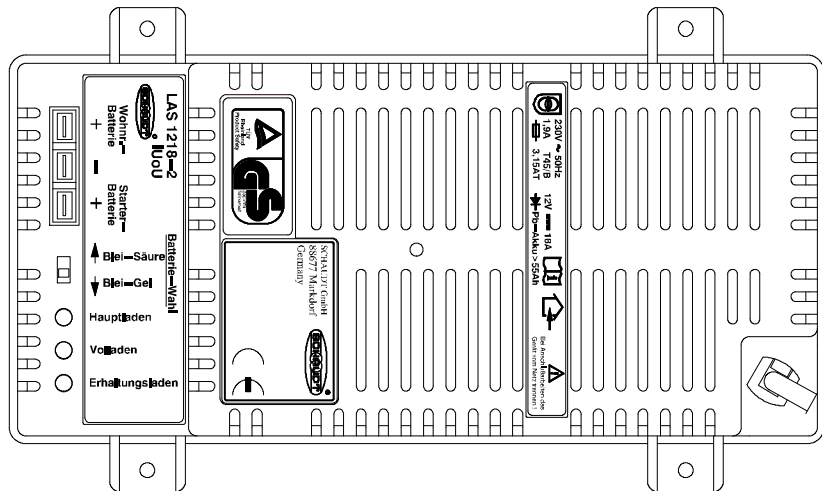

LAS 1218-2 Battery Charger

Table of contents

1	Instruction manual	2
1.1	Safety information	2
1.2	Introduction	3
1.3	Operation	4
1.4	Maintenance	7
2	Installation instructions	8
2.1	Introduction	8
2.2	Mechanical installation	8
2.3	Electrical connection	9
2.4	Initial use	16
2.5	Technical details	17
2.6	Storage - Packaging - Transportation	18
	Appendix	19

1 Instruction Manual

1.1 Safety Information

1.1.1 Meaning of safety symbols



▲ DANGER!

Failure to heed this warning may result in death or serious injury.



▲ WARNING!

Failure to heed this warning may result in personal injuries.



▲ ATTENTION!

Failure to heed this warning may result in damage to the device or connected consumers.

1.1.2 General safety information

The device is state-of-the-art and complies with approved safety regulations. Nonetheless, personal injuries or damage to the device may occur if the safety instructions contained herein are not followed.

Ensure that the device is in perfect working order before use.

Any technical faults which may impact personal safety or the safety of the device must be rectified immediately by qualified personnel.



▲ DANGER!

230V mains voltage carrying parts.

Danger of death due to electric shock or fire:

- The electrical system of the motorhome or caravan must comply with current DIN, VDE and ISO regulations.
- Connect devices rated at 230V to the 230V supply in line with national installation regulations.
- Never modify the device.
- Only carry out electrical work once the 230V supply has been disconnected.
- Never try to start the device using a defective mains cable or with a faulty connection.
- Never carry out maintenance work on live devices.
- Ensure proper electrical connections are made.
- Ensure correct electrical fuses are used.
- The mains connection line may only be replaced by an authorised customer service department or by qualified persons.



▲ WARNING!

Hot components!

Burns:

- Only change blown fuses when the device is completely de-energised.
- Only replace blown fuses once the cause of the fault has been identified and rectified.
- Never bypass or repair fuses.
- Only use original fuses rated as specified on the device or in these instructions.
- The rear of the device may become hot during operation. Do not touch.
- Never store heat sensitive objects close to the device (e.g. temperature sensitive clothes if the device has been installed in a wardrobe).

1.2 Introduction

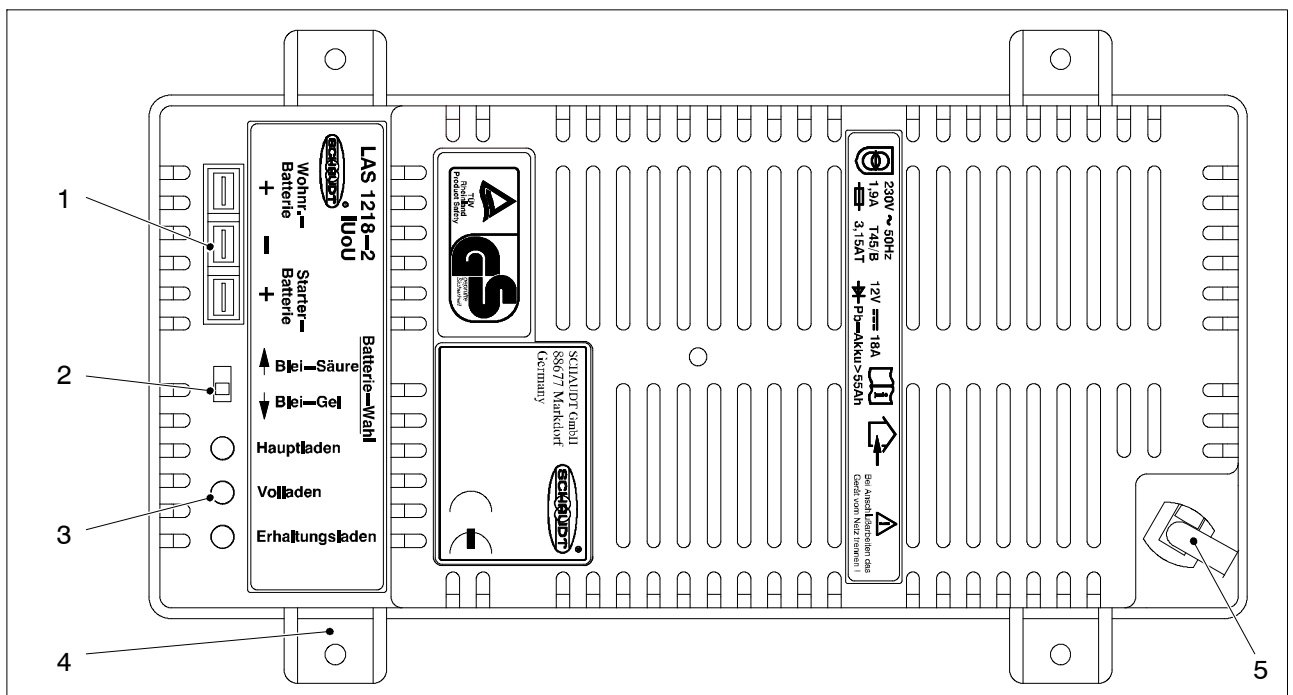

Fig. 1 LAS 1218-2 battery charger

- 1 Living area and start battery connectors
- 2 Battery selector switch
- 3 Indicator lamps for charging cycle
- 4 Installation feet
- 5 Mains cable with earthing type plug or WAGO®-connector (optional)



▲ This device is not intended to be used by persons (including children) with limited physical, sensory or mental aptitude or lack of experience and/or knowledge unless they are supervised by a person responsible for their safety or have received instruction from this person as to how the device is used.

▲ Children are to be supervised so as to ensure they do not play with the device.

▲ This device is intended for installation into a vehicle.

The LAS 1218-2 battery charger is for charging suitable batteries during 230V operation or supplying 12V consumers without connected battery with power.

The device is a primary controlled switch-mode power supply unit. This modern switching technology achieves high charging performance at a compact size and low weight.

The battery charger can be used:

- as a battery charger for charging the living area battery and for re-charging a connected starter battery
- as an additional charger for charging the living area batteries having a higher capacity which match every Schaudt electroblock with a type LAS charger module
- as a power supply unit (up to 18 A) for the 12V consumers connected. No battery is required here.

1.3 Operation

1.3.1 Controls and indicator lamps

The device has no controls which need to be used on a day-to-day basis. The battery selector switch need only be set correctly on initial use and for a change of battery.

Battery selector switch



▲ DANGER!

Risk of explosion!

- An incorrect battery selector switch setting poses a risk of explosion due to the formation of electrolytic gases.



▲ ATTENTION!

- An incorrectly set battery selector switch damages the living area battery.
- Disconnect the battery charger from the mains before adjusting the battery selector switch.

Changing the battery

- Batteries may only be replaced by qualified personnel.
- Follow the battery manufacturer's instructions.
- Charging unsuitable types of battery may damage them beyond repair.

It is possible to swap lead acid batteries for lead gel batteries.

Given the lack of ventilation options within the vehicle, changing from lead gel to lead acid batteries is not possible without additional overhead.

Ask your dealer for advice.

The switching option provided by the battery selector switch ensures optimum charging of the two battery types, lead gel and lead acid. The switch must be set to the correct battery type – lead acid or lead gel.

Use a thin object (e.-g.- a ballpoint pen cartridge) to move the battery selector switch.



▲ Suitability must be checked on a case-by-case using specifications from the battery supplier and the charging parameters of Schaudt equipment. The charging parameters are specified in the operating and installation instructions.

- ▶ Setting lead gel battery: Set the battery selector switch to "Lead-gel".
- ▶ Setting lead acid battery: Set the battery selector switch to "Lead-acid".
- ▶ If the battery charger is used to supply 12V consumers without connected battery with power, the battery selector switch must be set to "Lead-acid".

The indicator lamps on the front of the battery charger show the current charging phase.

Main charge



This indicator lamp lights up yellow in the "Hauptladen" (Main charge) phase.

Full charge



This indicator lamp lights up yellow in the "Vollladen" (Full charge) phase.

Trickle charge



This indicator lamp lights up green in the "Erhaltungsladen" (Trickle charge) phase.



▲ If the batteries are totally discharged, indicator lamp "Erhaltungsladen" (Trickle charge) or "Vollladen" (Full charge) may light up for a while before the main charging phase begins.

1.3.2 System faults

Flat vehicle fuses

A fault in the power supply system is usually caused by a blown fuse.

Please contact our customer service department if you are unable to rectify the fault using the following table.

If this is not possible, e.g. if you are abroad, you can have the battery charger repaired at a specialist workshop. Please note that the warranty becomes void if incorrect repair work is carried out. Schaudt GmbH cannot accept liability for any damages resulting from such repairs.

Fault	Possible cause	Remedy
Living area battery is not charged during 230V operation (battery voltage continuously less than 13.3V)	No mains voltage	Switch on the circuit breaker in the vehicle Have the mains voltage checked
	Battery charger is defective	Contact the customer service department
	Battery charger fuse or wiring is defective	Check the fuse and wiring
Living area battery is overcharged during 230V operation (battery voltage continuously greater than 14.5V)	Battery charger is defective	Contact the customer service department
Starter battery is not charged during 230V operation (battery voltage continuously less than 13.0V)	No mains voltage	Switch on the circuit breaker in the vehicle Have the mains voltage checked
	Battery charger is defective	Contact the customer service department
12V power supply in the living area does not work (when the battery charger is being used as a power supply device)	Defective fuse or wiring	Check the fuse and wiring
	Battery charger is defective	Contact the customer service department
	No mains voltage	Switch on the circuit breaker in the vehicle Have the mains voltage checked
The "Volladen" (Full charge) indicator lamp does not light up despite several hours of "Main charge" (duration dependent on battery type)	Defective battery	Contact the customer service department
The "Erhaltungsladen" (Trickle charge) indicator lamp does not light up despite several hours of full charge	Defective battery	Contact the customer service department
	If the battery is not defective: Battery charger defective	Contact the customer service department



- ▲ The charging current is reduced automatically if the device becomes too hot due to excessive ambient temperature or lack of ventilation. Always prevent the device from overheating nevertheless.

1.4 Maintenance

The battery charger is maintenance-free.

Cleaning Clean the battery charger with a soft, slightly damp cloth and mild detergent. Never use spirit, thinners or similar substances. Do not allow liquids to enter the device.

2 Installation instructions

2.1 Introduction

These installation instructions are aimed at trained personnel.

They contain important information on the connection and safe operation of the device. The safety information provided must be observed.

Always follow the relevant instruction manual in addition to the installation instructions.

The following applications are described for the electrical connection (with the appropriate deliverables):

- Auxiliary charger on electroblock (section 1.1.1.1)
- Direct connection to living area and starter battery (section 1.1.1.2)
- Connection to additional battery (e.g. when using in conjunction with an inverter) (section 1.1.1.3)

2.2 Mechanical installation

2.2.1 LAS 1218-2 battery charger



▲ This device is intended for installation into a vehicle.

The device was designed for floor installation.

Environment ► Install in a dry, sufficiently ventilated location. No condensation is allowed to form on the device. To prevent a build-up of heat, ventilation holes facing the living area must be provided in the upper and lower areas of the place of installation. Its cross-section is based on the size and average temperature of the place of installation.

Minimum clearance ► Keep a minimum clearance to the surrounding fixtures and fittings:

- Maintain a gap of at least 5cm on all sides (except mounted side).
- Whilst in operation, the ambient temperature must not exceed +40 °C, measured 2.5 cm away from the sides of the device.

Fitting ► Screw the battery charger onto a firm, flat base with four screws (5mm diameter).

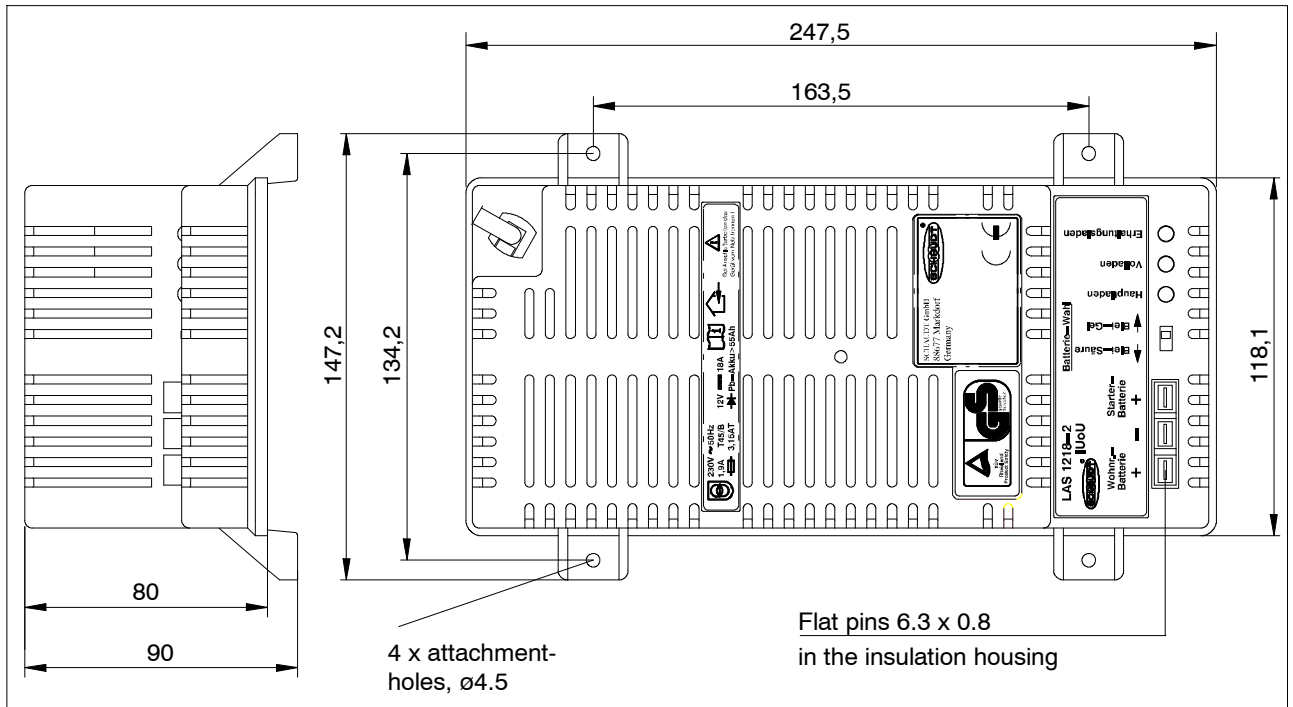

Fig. 1 Dimension diagram of LAS 1218-2 battery charger (dimensions in mm)

2.2.2 Fuse holder

For applications that require one or two additional fuses (see sections 1.1.1.2 and 1.1.1.3 for example), fuse holders from the connector set must be installed.

- Determine the place of installation of the fuse holder(s). The place of installation must be in the direct vicinity of the corresponding battery.
- Drill a hole 8mm in diameter for every fuse holder.
- Lock the fuse holder into place in the drillhole.

2.3 Electrical connection

Connection sequence The battery charger connection is established in the following order:

1. All connections on the front panel of the battery charger
2. Battery lines to the battery terminals
3. 230V mains connection

Disconnecting Disconnect in the reverse order.

2.3.1 Connections on the front panel



▲ ATTENTION!

Short circuits!

Damage to the battery charger or fire damage to cable:

- To protect the supply lines in the event of a short circuit, connect the fuses directly to the positive terminal of battery.

Select cable cross-sections in line with EN 1648-1/-2. The maximum current load must not exceed 90% of the individual fuse rating.

Recommended cable cross-sections:

Line length* (sum of supply and return lines)	Cable cross-section
Up to 4 m	2,5 mm ²
Up to 8 m (only for living area battery)	4,0 mm ²
Up to 12 m (only for living area battery)	6,0 mm ²

Fusing ➤ Fuse the supply lines as follows:

- with 1.5 mm² cable cross-section 10 A
- with 2.5 mm² cable cross-section (or greater) 20 A

1.1.1.1 Connection as for auxiliary charger to the electroblock

Auxiliary charger The LAS 1218-2 battery charger can also be used as an auxiliary charger for a Schaudt electroblock. Suitable for use here are all Schaudt electroblocks that include the LAS charger module and have the 2-pin MN connector (e.g. EBL 99) or Minit connector (e.g. EBL 220) for an auxiliary charger. See the instruction manual for the electroblock, "Suitable accessories".

Deliverables The following parts are supplied for this application:

- Item number 999.085 with MNL connector
- Item number 999.161 with Minit connector

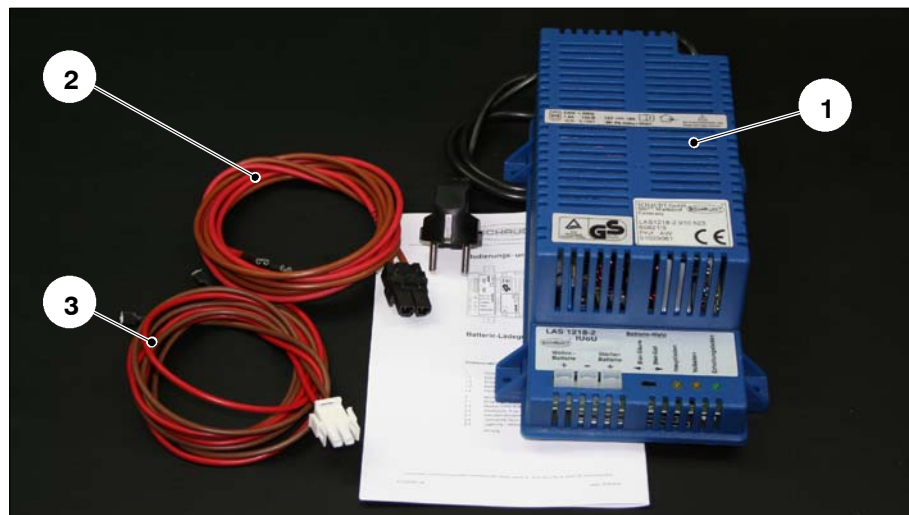

Fig. 2 Connector set deliverables

Pos.	Qty	Name
1	1	LAS 1218-2 battery charger, earthing type plug connection example
2	1*	Connector cable, 1.7m with Minit connector
3	1*	Connector cable, 1.7m with MNL connector

* Pos. 2 and 3 as an alternative depending on electroblock to be connected

The connector cable (Pos. 2 or 3) is required to connect the LAS 1218-2 battery charger to the electroblock.

Fusing An additional fuse is not required as there is already one integrated in the electroblock. You only have to check if the fuse is fitted and if it complies with the fuse rating on the label.

The battery charger is connected to the electroblock with a 2-pin charger cable. Other lengths are available on request.

A connection to the starter battery is not required, because the electroblock already has the start battery recharge module.

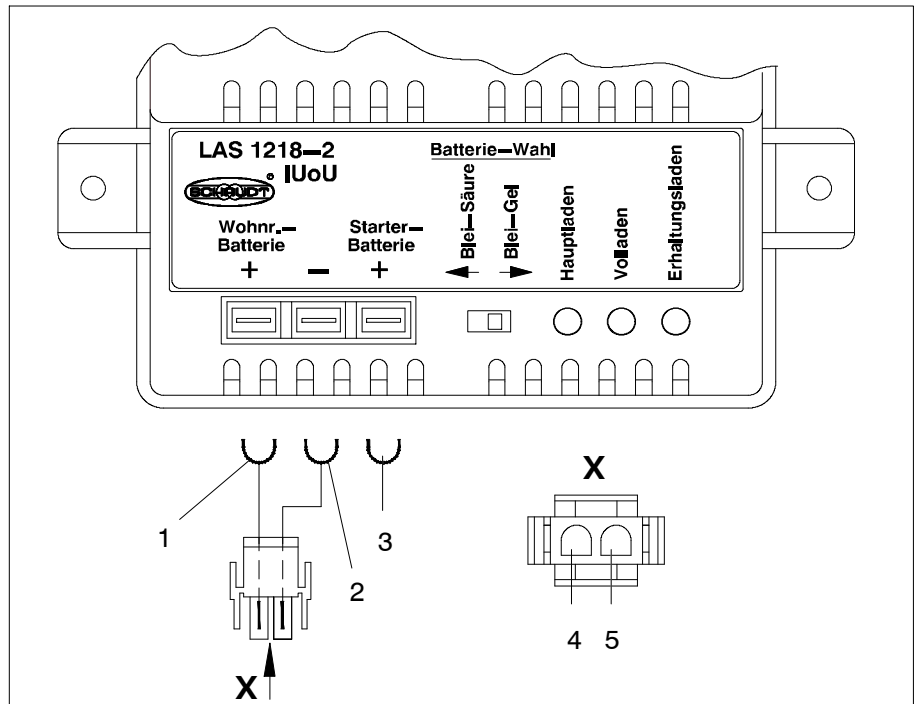

Fig. 3 Connection Diagram of LAS 1218-2 Battery Charger - on Electroblock

- 1 Flat push-on contacts, 6.3 x 0.8, red cable
- 2 Flat push-on contacts, 6.3 x 0.8, brown cable
- 3 not assigned
- 4 + Living area battery (red)
- 5 Negative battery (brown)

➤ 2-pin charger cable: LAS 1218-2 to electroblock connection

- + terminal of LAS 1218-2 living area battery: Flat push-on contact, 6.3 x 0.8; (Fig.3; Pos. 1)
- - terminal of LAS 1218-2: Flat push-on contact, 6.3 x 0.8; (Fig.3; Pos. 2)
- MNL connector (view X, Fig. 3; Pos. 4/5) or Minifit connector on electroblock, base "auxiliary charger" ; see also instruction manual for electroblock

1.1.1.2 Direct connection to living area and starter battery

For this type of connection, there is a direct connection between the LAS 1218-2 battery charger and the two motorhome batteries (or also only one battery, e.g. for a caravan).

Deliverables The following parts are supplied under item number 999.086 for this application:

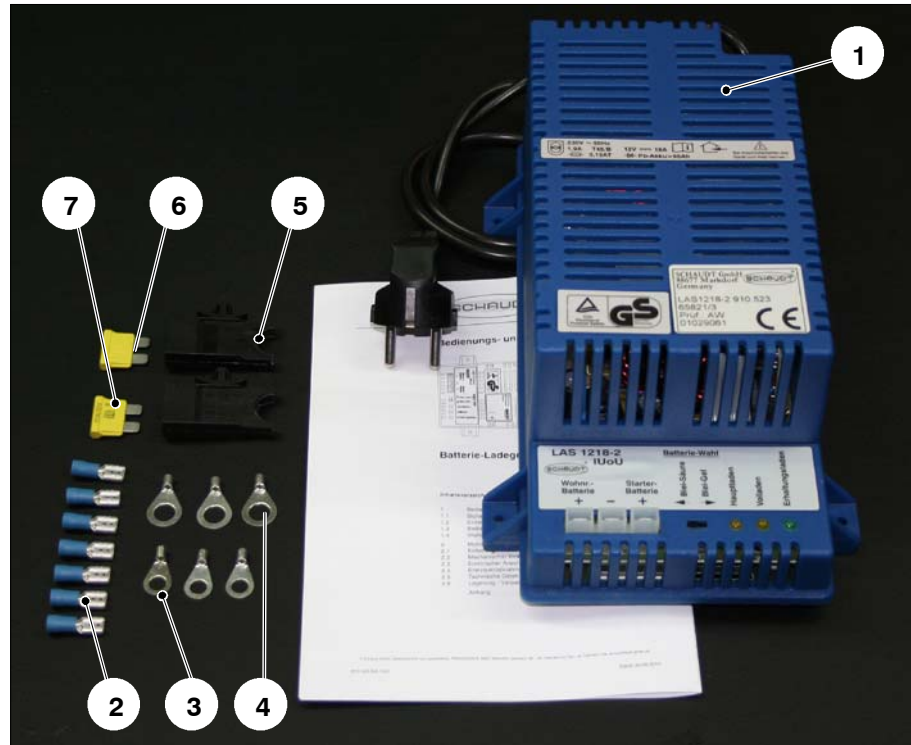

Fig. 4 Connector set deliverables

Pos.	Qty	Name
1	1	LAS 1218-2 battery charger
2	7	Flat push-on contacts, 6.3 x 0.8 (blue)
3	3	Ring terminal, 1 ... 2.5 mm ² M6
4	3	Ring terminal, 1 ... 2.5 mm ² M8
5	2	Fuse holder for flat vehicle fuse
6	1	Flat vehicle fuse, 20A
7	1	Flat vehicle fuse, 10 A

The connector set (Pos. 2 to 6) is required to connect the LAS 1218-2 battery charger to up to two batteries.



▲ The length of the line to the starter battery may not exceed 4 m (supply and return lines together) for a cable cross-section of 2.5mm² (see also table on page 10).

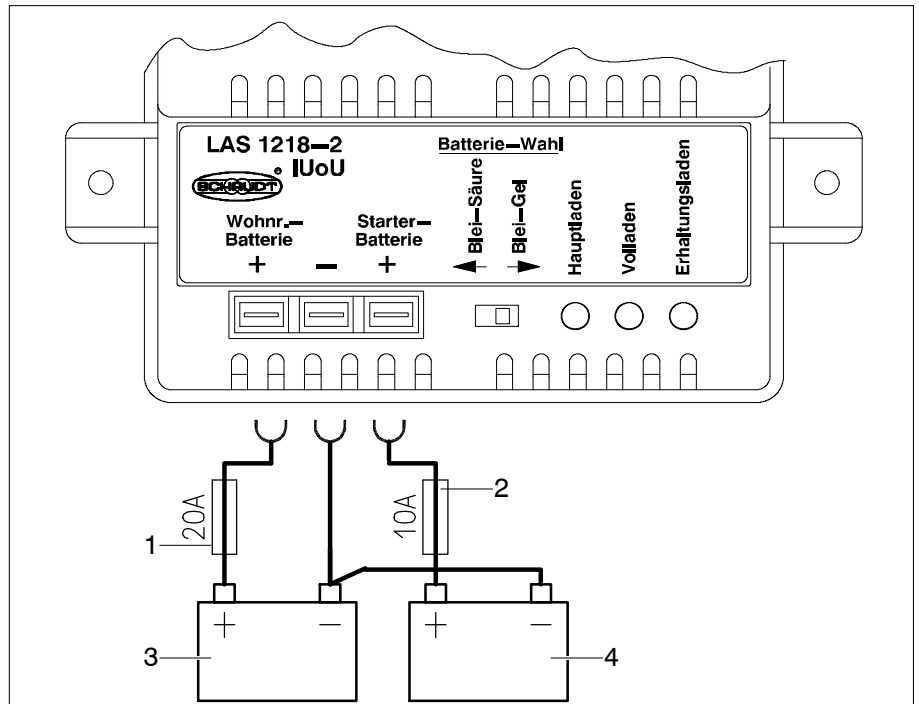

Fig. 5 Connection Diagram, LAS 1218-2 Battery Charger to Living Area and Starter Battery

- 1 Fuse F1
- 2 Fuse F2
- 3 Living area battery
- 4 Starter battery

- + terminal of LAS 1218-2 living area battery (flat push-on contact 6.3 x 0.8) to F1 (flat push-on contact 6.3 x 0.8)
- F1 (flat push-on contact 6.3 x 0.8) to + terminal of living area battery (ring terminal, M6 or M8)
- + terminal of LAS 1218-2 starter battery (flat push-on contact 6.3 x 0.8) to F2 (flat push-on contact 6.3 x 0.8)
- F2 (flat push-on contact 6.3 x 0.8) to + terminal of starter battery (ring terminal, M6 or M8)
- Connection, LAS 1218-2 to living area or starter battery
 - - terminal of LAS 1218-2 (flat push-on contact 6.3 x 0.8)
 - - terminal of battery (ring terminal, M6 or M8)
- Label the two fuses with stickers "F1 - living area battery" and "F2 - starter battery".
- ▲ The negative terminal (- Pol) of the living area battery must be connected externally to the negative terminal (- Pol) of the starter battery.



1.1.1.3 Connection to additional battery (such as when using in conjunction with inverter)

With this type of connection, the LAS 1218-2 battery charger is used for loading an additional battery.

Deliverables The following parts are supplied under item number 999.086 for this application:

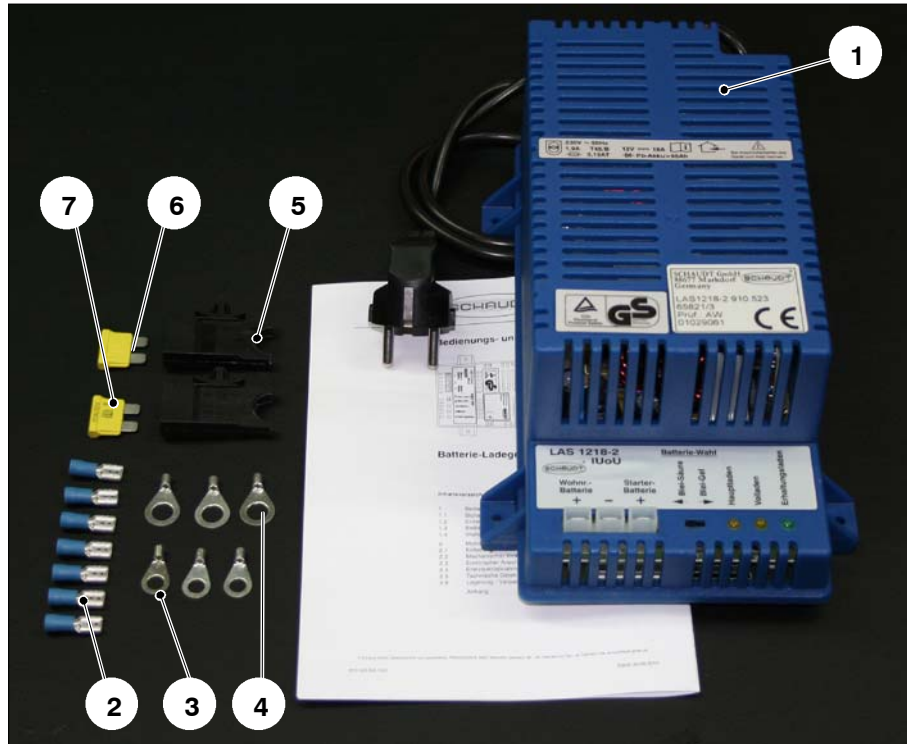

Fig. 6 Connector set deliverables

Pos.	Qty	Name
1	1	LAS 1218-2 battery charger
2	7	Flat push-on contacts, 6.3 x 0.8 (blue)
3	3*	Ring terminal, 1 ... 2.5 mm ² M6
4	3*	Ring terminal, 1 ... 2.5 mm ² M8
5	2*	Fuse holder for flat vehicle fuse
6	1	Flat vehicle fuse, 20A
7	1*	Flat vehicle fuse, 10 A

* Pos. 3 and 4 each only required 2 x, Pos. 5 only 1 x, Pos. 7 not used.

The connector set (Pos. 2 to 6) is required to connect the LAS 1218-2 battery charger to the additional battery.

The application shown in Fig. 7 is based on articles "Connector sets for integration of an inverter" (article nos 798.023 and 999.208) available from Schaudt. In principle, such a connection is always suitable when an addition battery is charged.



- ▲ The length of the line to the additional battery may not exceed 4 m (supply and return lines together) for a cable cross-section of 2.5mm² (see also table on page 9).
- + terminal of LAS 1218-2 (flat push-on contact 6.3 x 0.8) to F4 (flat push-on contact 6.3 x 0.8)

- F4 (flat push-on contact 6.3 x 0.8) to + battery terminal (ring terminal, M6 or M8)
- LAS 1218-2 to additional battery connection
 - - terminal of LAS 1218-2 (flat push-on contact 6.3 x 0.8)
 - - terminal of battery (ring terminal, M6 or M8)
- Label the additional fuse with sticker "F4 - additional battery".

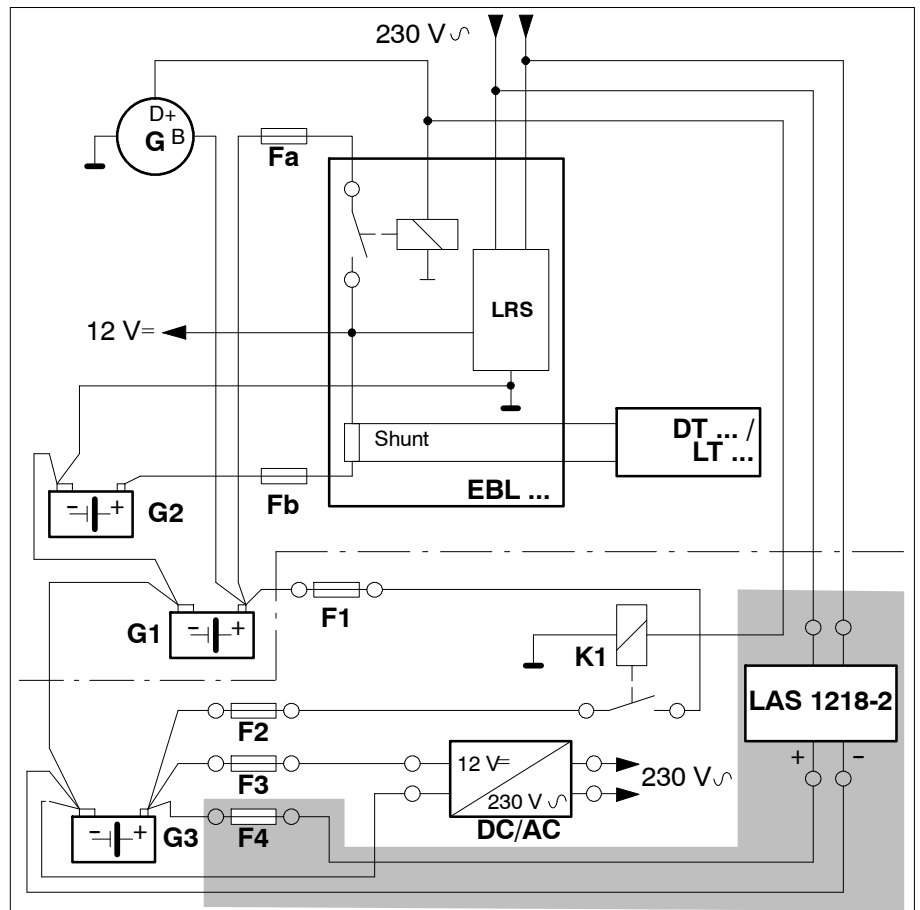

Fig. 7 Example circuit diagram, inverter installation
(grey background: LAS 1218-2 battery charger with connector set)

Pos.	Name	Pos.	Name
DC/AC	Inverter	F4	Fuse, additional battery charge current
DT.../LT...	DT ... or LT ... control and display panel in the vehicle	G	Vehicle alternator (higher rating)
EBL ...	Electroblock	G1	Starter battery
Fa	Fuse, EBL ... charge current for starter battery	G2	Living area battery
Fb	Fuse, EBL ... charge current for living area battery	G3	Additional battery
F1	Fuse, starter battery - cut-off relay	K1	Cut-off relay, starter battery - additional battery
F2	Fuse, cut-off relay - additional battery	LAS 1218-2	Battery charger
F3	Fuse, inverter supply	LAS	Charger module of electroblock

2.3.2 Mains connection



▲ DANGER!

230V mains voltage carrying parts.
 Danger of death due to electric shock or fire:

- Only carry out electrical work once the 230V supply has been disconnected.

Mains connection

- The mains must be connected as follows:
 - to a insulated distribution unit with protective contact
 - to a socket with protective contact (isolated ground or suitable plug connector from WAGO®, depending on LAS 1218-2 variant).

The power cord must be of type H05VV-F 3x1.5.

- The mains cable must have a strain relief where required.

2.4 Initial use

2.4.1 Checks prior to initial use

Before starting up

- Ensure that the batteries are connected properly (only for initial use, operation without battery is possible in general).

2.4.2 Setting battery type



▲ DANGER!

Incorrect setting of the battery selector switch.
 Risk of explosion from build-up of electrolytic gas, defective battery, defective battery charger or as a result of too high a battery operating temperature (above 30 °C):

- Move the battery selector switch to the correct position.
- The battery charger is to be used solely for connecting to the 12V power supply with rechargeable 6-cell lead-gel or lead-acid batteries. Do not use any unsuitable battery types.

- Store batteries in a place with adequate ventilation (or provide integrated ventilation). Follow the instructions provided by the battery manufacturer.

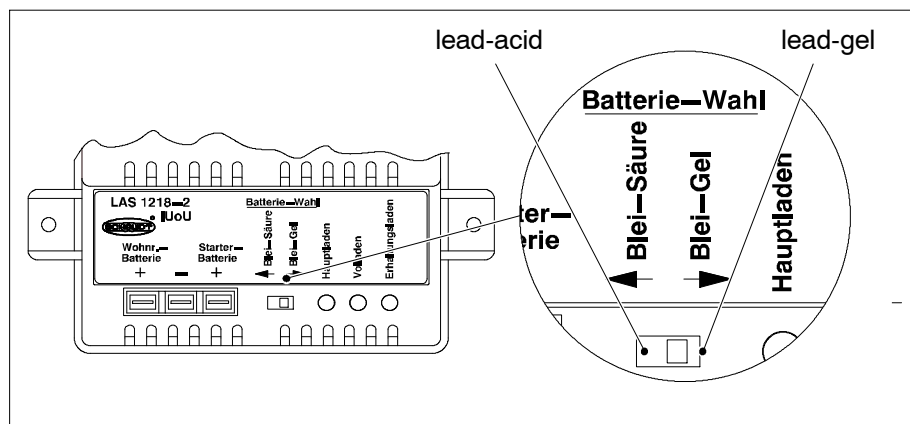

Fig. 8 Battery selector switch lead-gel-/lead-acid battery.

- Disconnect the battery charger from the mains before moving the battery selector switch.
- Move the battery selector switch (see Fig. 8) into the correct position using a thin object, such as a ballpoint pen:
 - Lead gel battery: Move the battery selector switch to "Lead-gel".
 - Lead acid battery: Set the battery selector switch to "Lead-acid".
- Re-check that the battery selector switch is set correctly for the type of battery used.



- ▲ Suitability must be checked on a case-by-case using specifications from the battery supplier and the charging parameters of Schaudt equipment. The charging parameters are specified in the operating and installation instructions.

2.4.3 Starting up the system

- Ensure that the battery is connected correctly (or all if more than one is available).
- 230V mains supply must be connected to vehicle.
- Power on the electrical system of the vehicle (e.g. power on 12V main switch on the switch panel, see instruction manual for switch panel connected).
- 230-V- mains cable of the LAS 1218-2 charger must be connected (the charger does not have its own mains switch).
- Check whether the batteries are being charged (display on the battery charger).

2.5 Technical details

2.5.1 Mechanical details

Dimensions	ca. 90 x 148 x 248 (H x W x D in mm), including attachment feet
Weight	1.0 kg
Housing	Polyamide blue, similar to RAL 5010

2.5.2 Electrical details

Mains connection	230 V AC voltage +10%, 47 - 63 Hz sinusoidal, protection class I
Current consumption	1.9 A
Suitable batteries	6-cell lead acid or lead gel batteries, 55 Ah and above
Standby current from living area battery	approx. 0.3 mA
	Conditions for the measurement:
	<ul style="list-style-type: none"> ● approx. 10 min after mains isolation without mains connection ● with battery connected (battery voltage 12.6V)

Battery charging via mains connector	Living area battery	
	Charging curve	IUoU
	Final charging voltage	14.3 V
	Charge current	18 A in the entire mains voltage range, electronically limited, minus the charge current into the vehicle battery
	Voltage for float charge	13.8 V with automatic switchover
	New charge cycle, Switchover to main charging	with battery voltage below 13.8 V with approx. 5 seconds delay

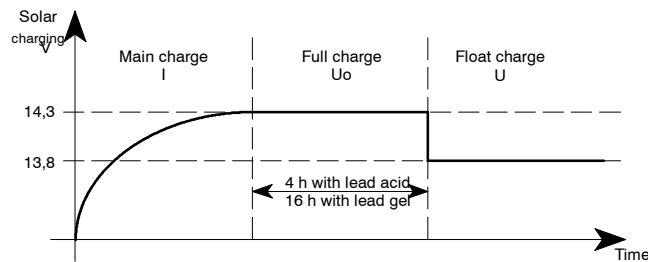

Fig. 9 Example of the charge voltage behaviour with the LAS 1218-2 battery charger

- I Main charge with maximum 18 A charging current, electronically limited, up to final charging voltage. Start of charge also for totally discharged batteries.
- Uo Automatic changeover to full charge with constant 14.3 V. The duration of the full charge phase depends on the type of battery and is configured on the device: Lead-acid batteries, 4 hour, lead-gel batteries, 16 hours.
- U Automatic changeover to trickle charge with constant 13.8V. In the trickle charge phase, the voltage at the output of the charging module is constant. The battery is now fully, or virtually fully, charged.

Start of a new charging cycle by switching over to main charge, if the battery voltage falls below 13.8 V for more than 5 seconds when loaded. Start of charge also for totally discharged batteries.

Battery charging of the starter battery	For mains operation, the starter battery is also charged (with maximum charge current of 3A). The final charge voltage is 14.1 V.
Operation as power supply unit	Output current 18 A, connection of a battery not required Output voltage 14.3V/13.8V, suitable for 12V consumers, smoothed DC voltage

2.5.3 Environmental parameters

Operating temperature	-20 °C to +45 °C
Storage temperature	-20 °C to +70 °C
Humidity	Operation in dry environment only
CE	CE mark

2.6 Storage - Packaging - Transportation

Only transport and store the battery charger if the packing is suitable and ambient conditions are dry.

© No part of this manual may be reproduced, translated or copied without express written permission.

Appendix

A EC Declaration of Conformity

Schaudt GmbH hereby confirms that the design of the device complies with the relevant regulations.

The original EU conformity declaration is available and can be referred to at any time.

Manufacturer Schaudt GmbH, Elektrotechnik & Apparatebau

Address Planckstrasse 8
88677 Markdorf
Germany

B Accessories

Additional charger Suitable connector cable (MNL or Minifit) to Schaudt eletroblock.

As a standalone device Connector set with fuse holders and connector material

C Customer service

Customer service address Schaudt GmbH, Elektrotechnik & Apparatebau
Planckstraße 8
D-88677 Markdorf

tel.: +49 7544 9577-16

email: kundendienst@schaudt.de

web: www.schaudt.gmbh

Send in the device Returning a defective device:

- Fill in and enclose the fault report, see Appendix D.
- Send it to the addressee (free of charge).

D Fault report

In the event of damage, please return the defective device together with the completed fault report to the manufacturer.

Device type: _____
Item no.: _____
Vehicle: Manufacturer: _____
Model: _____
Own installation? Yes No
Upgrade? Yes No

Following fault has occurred (please tick):

- Electrical consumers do not work – which?
(please specify below)
- Switching on and off not possible
- Persistent fault
- Intermittent fault/loose contact

Other remarks:
